

THE
RICHWAY
GROUP

Richway & Fuji Bio Inc.
SHAOXING RICHWAY TRADING Co.,Ltd.
Richway Europe B.V.
Richway & Life Japan Corp.
R&L Co., Ltd.



BIOMAT User Manual

TheBiomatShop.com
1-855-324-6628

READ AND FOLLOW THE INSTRUCTIONS IN THIS MANUAL TO PREVENT PERSONAL HARM AND PROPERTY DAMAGE.

Contents

- Safety Precautions2**

- Read before operating the product9**
 - Product components..... 9
 - Product description 12

- Product installation17**
 - Checklist before product installation 17
 - Product installation..... 18
 - Checklist after product installation..... 19
 - Product specifications..... 21

- How to use the product27**
 - Turning ON and OFF 27
 - Adjusting the product's temperature 29
 - Adjusting the product's operation time..... 30

- Useful information.....32**
 - How to clean and store the product 32
 - Trouble shooting guide 33
 - Check before contacting customer service 34
 - Customer service information 35
 - Product manufacturing information..... 35
 - Application specification 41
 - Symbol glossary..... 44
 - Product warranty..... 45

Safety Precautions

Read and follow all instructions in this manual. Proper use of the Biomat will prevent harm to the user and damage to private property.

The contents are described in three categories: Danger, Warning, and Caution.



Danger

Serious injury or death can occur if instructions are not followed properly.



Warning

Serious injury or death can occur if instructions are not followed properly.



Caution

Property damage and injuries may occur if instructions are not followed properly.



WARNING :

Use carefully. May cause serious burns. Do not use over sensitive skin areas or in the presence of poor circulation. The unattended use of the Biomat by children or incapacitated persons may be dangerous.

Do not modify or tamper with this device without authorization from the manufacturer.

- If the Biomat is not working properly, contact your local Customer Service Center.



Danger

Do not alter, change or disassemble the product.

- Doing so may cause the product to malfunction and risks electric shock and fire.

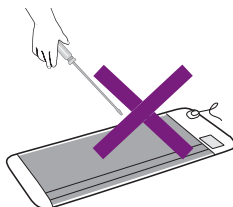

Make sure to use the proper voltage for your country.

- Improper voltage may cause the product to break or risks electric shock and fire.

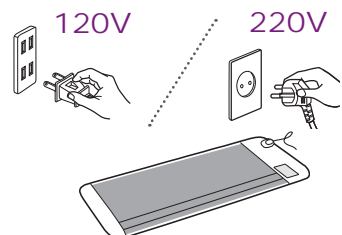

 **Warning**

Be sure the plug is firmly connected to the outlet before operating.

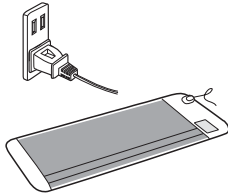

Turn off and unplug the device if the Biomat catches fire or begins to smoke.

- Report the problem to our Customer Service Center.

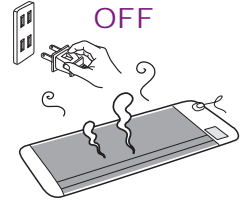

Make sure the power cord is in good condition before using. If there are cuts and tears in the cord do not use.

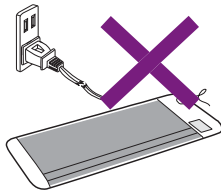

Do not pull on the power cord, controller or the connecting part of the controller and Biomat.

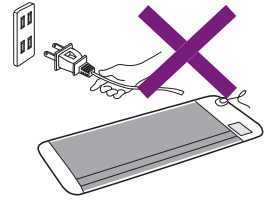

Do not plug the Biomat into a power strip with other devices. Problems may occur. Plug the Biomat into a dedicated outlet.

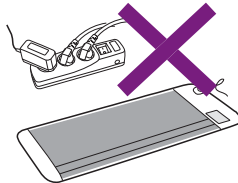

If there is a power outage, turn off the power and disconnect the plug.

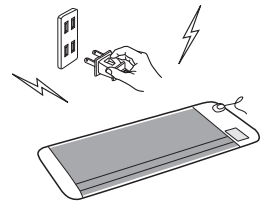

Do not use any metal products such as pins to secure the Biomat.

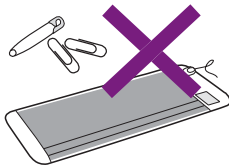

Do not drop, throw, or mishandle the Biomat controller.

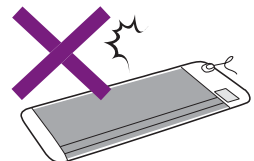

Warning

Do not use the Biomat in areas where it is very humid or can get wet.

- Doing so may cause electric shock or fire.

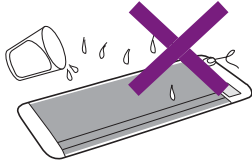

Do not submerge the Biomat in water to clean. Simply wipe with a moist towel.

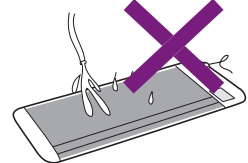

Do not use detergents, solvents, or flammable chemicals when cleaning the Biomat or controller.

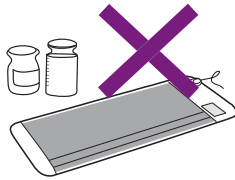

If you do not feel well as a result of using the Biomat, stop using it and consult with a physician.

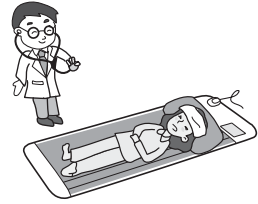

Do not use the Biomat if you are insensitive to heat. Doing so may cause problems.



Do not use the Biomat with any ointments, or creams which generate heat. Doing so may cause burns or injury to your skin.



If controller is set to 104°F - 158°F (40° - 70°C), low temperature burns can result if using the Biomat for a long period of time. Use with caution.



When using the Biomat, be sure to cover it with the cotton pad. Do not lay on the Biomat directly. - Doing so may cause burns or injury to your skin.

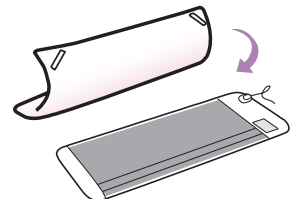

 **Warning**

Store the Biomat away from children. Do not allow a child to wrap the power cord around their necks. A child can die or be seriously injured.

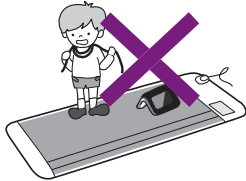

Store the Biomat away from children. A child can trip and fall over the power cord causing injury to the child and damage to the Biomat.



The Biomat is a medical device and should only be used by a competent adult. Elderly people with difficulty moving need to be supervised.

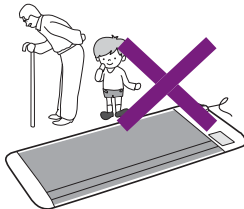

Do not use any auxiliary parts with the Biomat. This is not permitted and may cause injury, electric shock or fire.

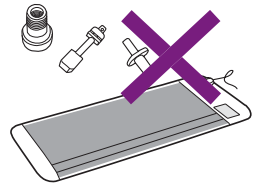

Do not use or connect the Biomat to any other electronic device. This may cause injury, electric shock or fire.

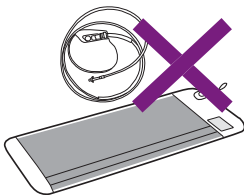



Caution

Keep the Biomat away from sharp objects. Do not allow anything to puncture the folds of the Biomat.

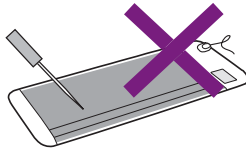

Do not run, stand, or place heavy objects on the Biomat.

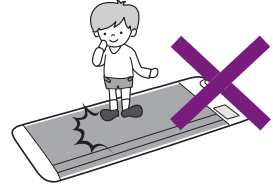

Do not place the controller on the Biomat when in use. Keep the controller away from the Biomat.

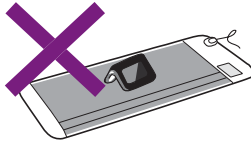

Do not operate the Biomat near objects which generate heat or magnetic fields such as ventilation from heaters, stoves, TV, magnetic objects, etc...

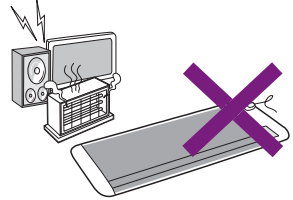

Unplug the Biomat before cleaning it. Use a vacuum to remove the dust on the Biomat's surface and use a soft dry fabric to wipe the controller.

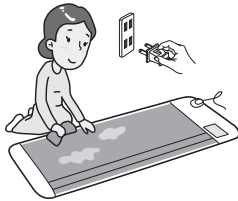

When not in use, turn off the power and unplug the Biomat.

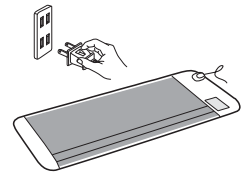

The Biomat should be stored in an area without humidity and dust.

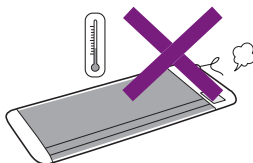



Safety Precautions

1. The Biomat should not be used by infants and young children. The Biomat is not indicated for the elderly. The elderly should consult with a physician prior to use.
2. If you have the following conditions, do not use the Biomat.
 - Person with organ transplants
 - Person with high fever
 - Person with cognitive disability
 - Person with skin problems on the area of use
 - Person with acute disease, acute tumor, the visually impaired, and any heart problems
3. If you have the following conditions, do not use the Biomat unless directed by a physician.
 - Person with immobility
 - Person with internal pacemaker/defibrillator
 - Person with Adrenal Suppression Disorders, Addison's Disease, Adrenal Insufficiency, Systematic Lupus Erythematosus, and Multiple Sclerosis (MS).
 - Person with bypass surgery
 - Person with diabetes
 - Person with high blood pressure (hypertension)
 - Infants
 - Person who is pregnant/expectant
 - Person who recently received radiation/chemotherapy
 - Person with surgical or silicone implants
4. If you have the following conditions, use the Biomat with caution (no heat/negative ions only).
 - Person with fever
 - Person with joint injuries
 - Person with insensitivity to heat
5. Do not use the Biomat if your skin is insensitive to temperature change.
6. FDA has not evaluated the Biomat for use while sleeping.
7. If using the Biomat for a long period of time, check your skin to make sure there are no burns or blisters. Stop using the Biomat if burns or blisters occur.
8. Do not run, stand, or place heavy objects on the Biomat.
9. Keep the Biomat away from sharp objects. Do not allow anything to puncture the folds of the Biomat.
10. Do not pull on the power cord, controller or the connecting part of the controller and Biomat.
11. Do not use the Biomat for any purpose other than heat therapy.
12. Do not alter, change or disassemble the product.
13. Before using the product, inspect the power cord to make sure there is no damage to it.
14. Do not plug the Biomat into a power strip with other devices. Problems may occur. Plug the Biomat into a dedicated outlet.
15. Stop using the Biomat if it is not functioning properly.
16. If there is a power outage, turn off the power and disconnect the plug.
17. If you do not feel well because of the Biomat, stop using it and consult with a physician.
18. Do not drop, throw, or mishandle the Biomat controller.
19. Any person who is sick or pregnant/expectant should consult with a physician before using the Biomat.
20. Do not use the Biomat if you have an external pacemaker.
21. If controller is set to 104° - 158°F (40° - 70°C), low temperature burns can result if using the Biomat for a long period of time. Use with caution.
22. When the Biomat is not in use, unplug it and store it in a dry area without humidity.
23. Unplug the Biomat before cleaning it. Use a vacuum to remove the dust on the Biomat's surface and use a soft dry fabric to wipe the controller.



BIOMAT

9 Before using the product

9 Product components

12 Product description

RICHWAY GROUP

Read before operating the product

Product components

The product components are described here.

※ The components may change without notice due to product improvement.

Mini Biomat

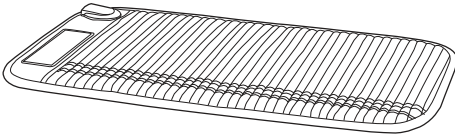

Biomat

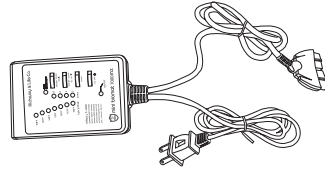

Biomat Controller / Power Cable

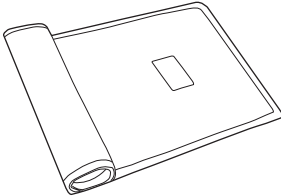

Cotton Pad

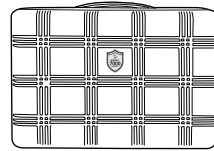

Carry Case

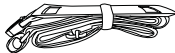

Carry Case Strap

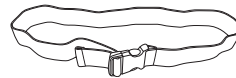

Elastic Band



User Manual

Professional / Single Biomat

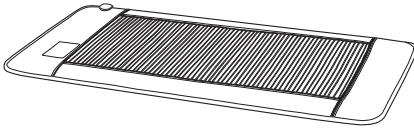

Biomat

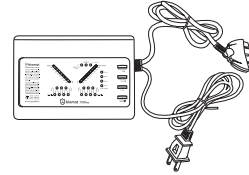

Biomat Controller / Power Cable

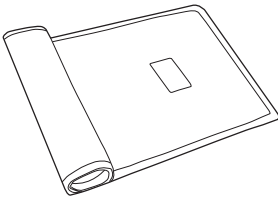

Cotton Pad

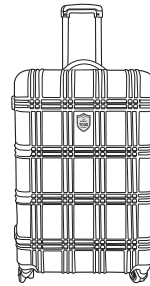

Carry Case *



User Manual

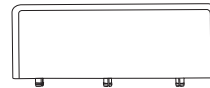

Controller Stand

* The Single Biomat does not come with a Carry Case. It comes with a Biomat Bag.

Queen / King Biomat

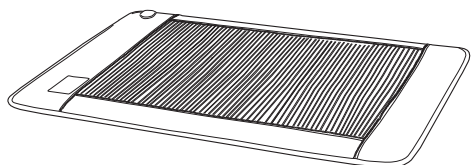

Biomat

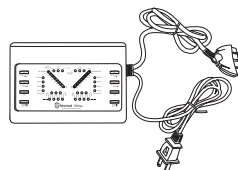

BIOMAT Controller / Power Cable

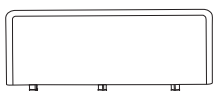

Controller Stand

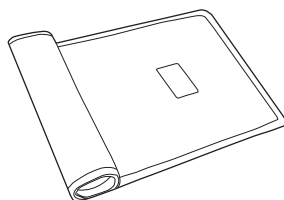

Cotton Pad

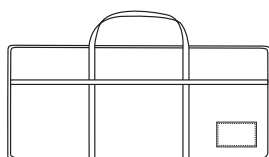

Biomat Bag



User Manual

Product description

Each part of the Biomat and how to operate it are described here.

Mat

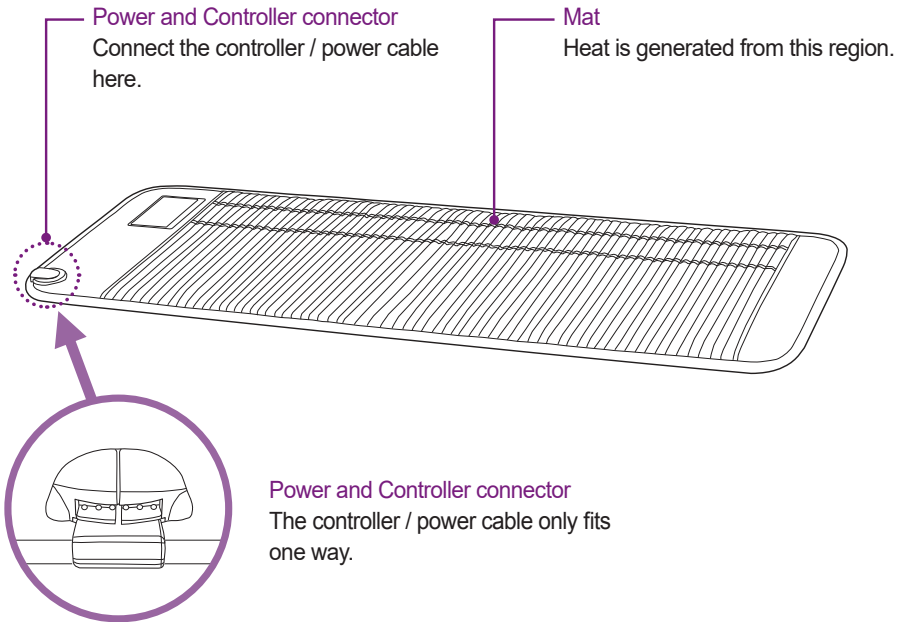

Reference

- The Queen and King Biomat's left and right temperature may be adjusted individually. Direction of the mat and the direction of the controller are shown in the figure on the right.

Controller Front

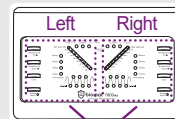

Queen / King Front

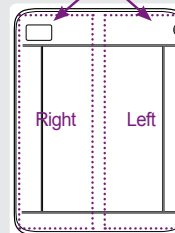

Controller

Mini_120V

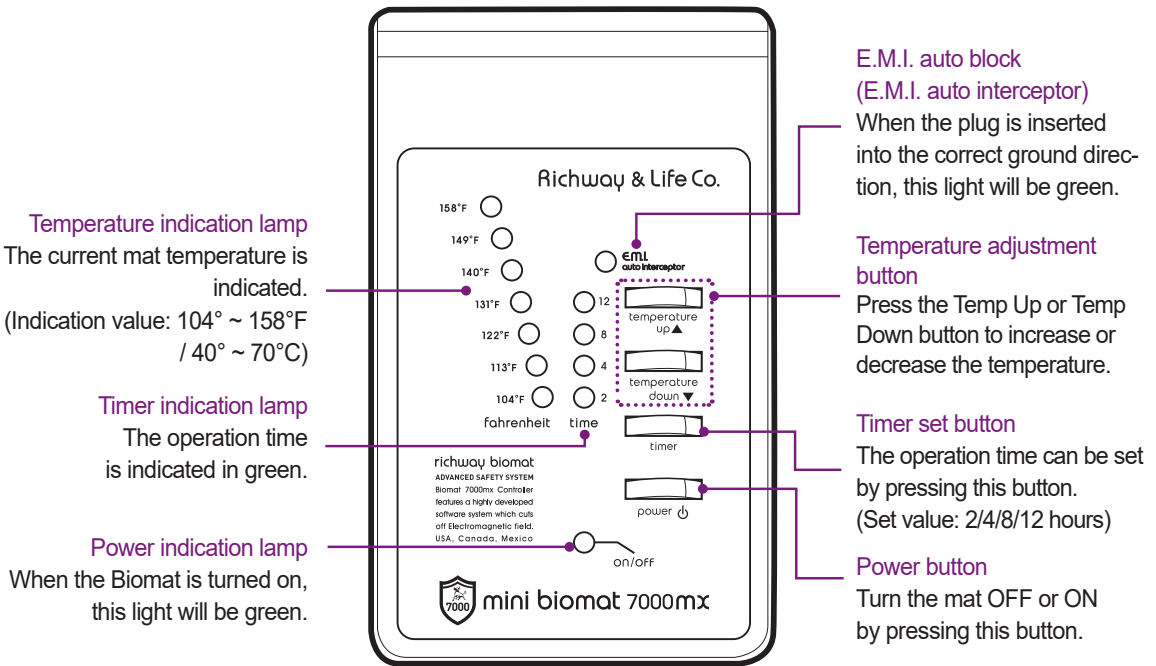

Mini_220V

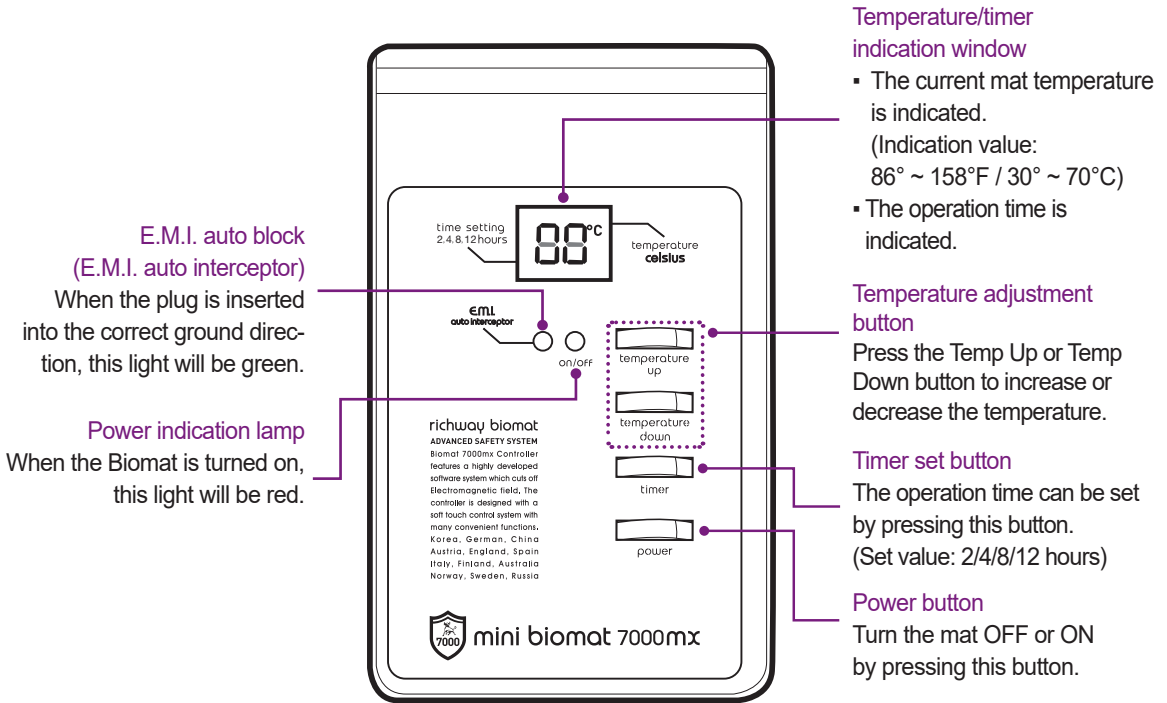

Professional / Single / Queen / King

Temperature indication lamp

The current mat temperature is indicated.
(Indication value: 95 ~ 158°F / 35° ~ 70°C)

Indication lamp

- Infrared ray active (FIR): When the mat temperature is increased, the green color will turn on and if it reaches the set temperature, the lamp will turn off.
- E.M.F. auto block: When the plug is inserted into the correct ground direction, this light will be green.
- Alarm: If any problems are detected during use, this light will flash red.

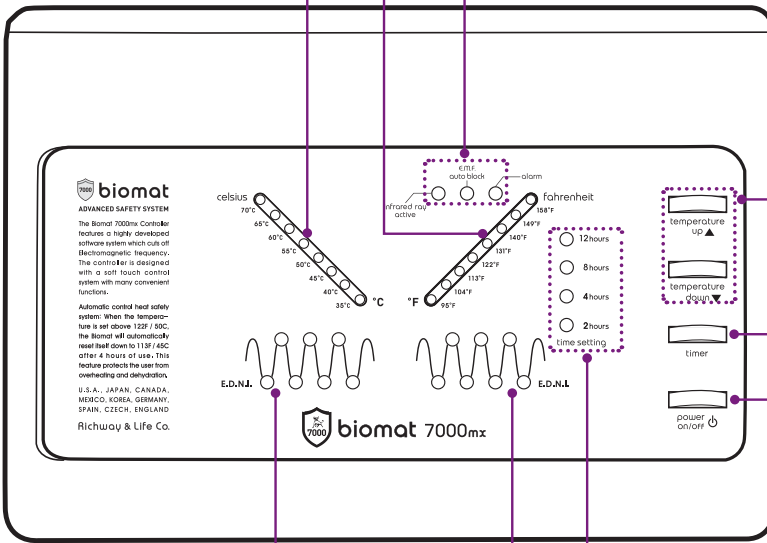

Temperature adjustment button

Press the Temp Up or Temp Down button to increase or decrease the temperature.

Timer set button

The operation time can be set by pressing this button.
(120V Set value: 2/4/8/12 hrs;
; 220V Set value: 2/4/8/12 hrs)

Power button

Turn the mat OFF or ON by pressing this button.

EDNI lamp

When the Biomat reaches the set temperature, the EDNI lamp will flash in blue.

Timer indicator lamp

The operation time is indicated in green.

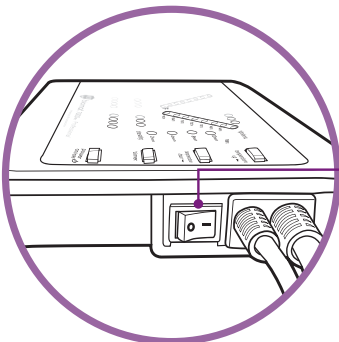

Main power switch

Turn the main power OFF or ON by flipping the switch.
"o" down = ON
"o" down = OFF



BIOMAT

17 Product installation

17 Checklist before product installation

18 Product installation

19 Checklist after product installation

21 Product specifications

RICHWAY GROUP

Product installation

Checklist before product installation

Check the following before using the Biomat.

1. Check if the floor of the area for product installation is flat.
 - If used in a non-flat area, the product may be damaged.
 - Do not place on surfaces sensitive to heat.

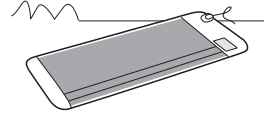

2. Do not use the product in area with high humidity or significant dust.

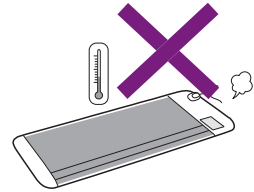

3. Handle the product with care. Any physical impact such as dropping the Biomat and/or controller can damage internal components.

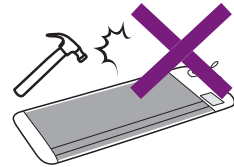

4. Check the voltage before installing the product.

- Voltage for the product: 120V or 220V
- Electric shock or damage to the Biomat can result from improper voltage.
- The Biomat's voltage must be the same as the controller's voltage. (120V Biomat + 120V Controller / 220V Biomat + 220V Controller)

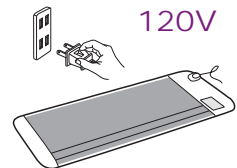

5. Inspect the plug, power cable, and power outlet for any damage.

- Do not use the Biomat if any of the above is damaged. Electric shock or fire can result from damaged components.

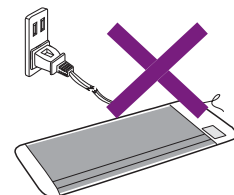

Product installation

To operate the Biomat follow the steps below.

1. Spread the Biomat out on a flat area. The side with the ridges should be facing up.



2. Connect the controller / power cable to the connection port of the Biomat. To ensure a secure connection, there should be no space between the two joinings. The connection may be tight at first.

NOTE: Use care when handling the controller / power cable to prevent accidental breakage. Do not drop, stand on or place heavy objects on the controller / power cable. Never pull the power cable to remove the plug from the receptacle, be sure to hold the plug.

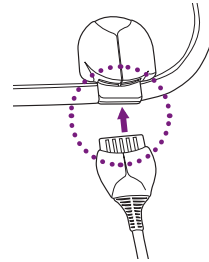

3. Plug the controller / power cable into a 120V or 220V outlet, depending on the voltage of the controller.

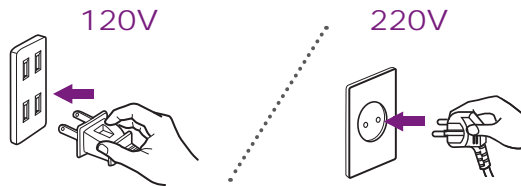

Checklist after product installation

Test the Biomat.

Mini

After turning on the Biomat, check the following to make sure the Biomat is operating properly.

1. Press the [Power] button on the controller and then check for any plug/power system problems.

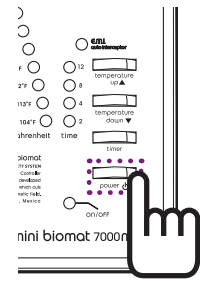

2. After turning on the Biomat, make sure the power light turns green.

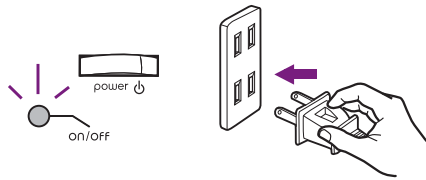

3. Press the [Temperature adjustment] button to see if it is working properly.
 - If the button of the controller is not working properly, please contact our Customer Service Center.

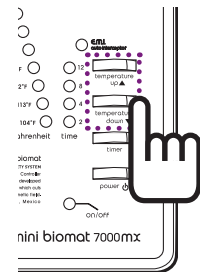

Professional / Single / Queen / King

Check the following to make sure the Biomat is operating properly.

1. Press the [Main power] switch on the side of the controller to turn on the power of the controller.

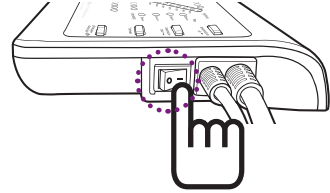

2. Press the [Power] button on the controller and then check for any plug/power system problems.

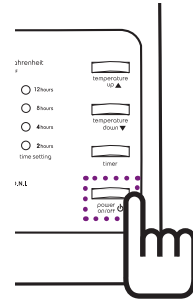

3. Press the [Temperature adjustment] button to see if it is working properly.
 - If the button of the controller is not working properly, please contact our Customer Service Center.

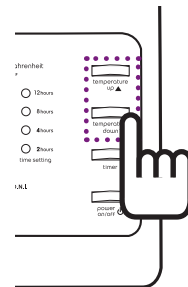

Product specifications

Mini

Category		Contents
Product name		BIOMAT
Model name		Mini Biomat
Country of manufacturing		Korea
Product size		500 x 850 mm
Manufacturing number and manufacturing date, weight or packing unit		1) Record after manufacturing 2) Weight: 5 KG, packing unit: 1 set
Operating temperature		120V: 104° ~ 158°F / 40° ~ 70°C 220V: 86° ~ 158°F / 30°~70°C
Capability and how to use		1) Capability: Refer to the manual 2) How to use: Refer to the manual
Precaution on use		Refer to the manual
Method of keeping and storage		Refer to the manual
Other required matters	Phase, frequency, rated voltage of rated power	120V~, 60Hz, 100 W / 220-240V~, 50/60Hz, 120 W
	Protection type and level on electric shock	Class II equipment, BF-type loading part
	Other required information	Refer to the manual
Type of protection against electric shock		Class II ME equipment
Degree of protection against electric shock		Class BF applied parts - Applied parts: Top of Mat
Degree of protection against harmful ingress of water		Ordinary equipment (IPX0) - Equipment not suitable for use in presence of a flammable anesthetic mixture with air or with oxygen or nitrous oxide.
Mode of operation		Continuous operation

Class II ME equipment (single fault safe)		
	Normal Mode	Single Fault Mode
Touch Current	< 100 microA	< 500 microA
Ground Leakage Current	< 5 mA	< 10 mA

Testing in accordance with IEC 60601-1-2 indicates the following:

The Biomat needs no special precautions regarding EMC and needs to be installed and put into service. Portable and mobile RF communications equipment have no adverse effects on the Biomat.

Professional

Category		Contents
Product name		BIOMAT
Model name		Professional Biomat
Country of manufacturing		Korea
Product size		700 x 1850 mm
Manufacturing number and manufacturing date, weight or packing unit		1) Record after manufacturing 2) Weight: 13.1 KG, packing unit: 1 set
Operating temperature		95° ~ 158°F / 35° ~ 70°C
Capability and how to use		1) Capability: Refer to the manual 2) How to use: Refer to the manual
Precaution on use		Refer to the manual
Method of keeping and storage		Refer to the manual
Other required matters	Phase, frequency, rated voltage of rated power	120V~, 60Hz, 180 W / 220-240V~, 50/60Hz, 210 W
	Protection type and level on electric shock	Class II equipment, BF-type loading part
	Other required information	Refer to the manual
Type of protection against electric shock		Class II ME equipment
Degree of protection against electric shock		Class BF applied parts - Applied parts: Top of Mat
Degree of protection against harmful ingress of water		Ordinary equipment (IPX0) - Equipment not suitable for use in presence of a flammable anesthetic mixture with air or with oxygen or nitrous oxide.
Mode of operation		Continuous operation

Class II ME equipment (single fault safe)		
	Normal Mode	Single Fault Mode
Touch Current	< 100 microA	< 500 microA
Ground Leakage Current	< 5 mA	< 10 mA

Testing in accordance with IEC 60601-1-2 indicates the following:

The Biomat needs no special precautions regarding EMC and needs to be installed and put into service. Portable and mobile RF communications equipment have no adverse effects on the Biomat.

Single

Category		Contents
Product name		BIOMAT
Model name		Single Biomat
Country of manufacturing		Korea
Product size		1000 x 2000 mm
Manufacturing number and manufacturing date, weight or packing unit		1) Record after manufacturing 2) Weight: 19.2 KG, packing unit: 1 set
Operating temperature		95° ~ 158°F / 35° ~ 70°C
Capability and how to use		1) Capability: Refer to the manual 2) How to use: Refer to the manual
Precaution on use		Refer to the manual
Method of keeping and storage		Refer to the manual
Other required matters	Phase, frequency, rated voltage of rated power	120V~, 60Hz, 180 W / 220-240V~, 50/60Hz, 210 W
	Protection type and level on electric shock	Class II equipment, BF-type loading part
	Other required information	Refer to the manual
Type of protection against electric shock		Class II ME equipment
Degree of protection against electric shock		Class BF applied parts - Applied parts: Top of Mat
Degree of protection against harmful ingress of water		Ordinary equipment (IPX0) - Equipment not suitable for use in presence of a flammable anesthetic mixture with air or with oxygen or nitrous oxide.
Mode of operation		Continuous operation

Class II ME equipment (single fault safe)		
	Normal Mode	Single Fault Mode
Touch Current	< 100 microA	< 500 microA
Ground Leakage Current	< 5 mA	< 10 mA

Testing in accordance with IEC 60601-1-2 indicates the following:

The Biomat needs no special precautions regarding EMC and needs to be installed and put into service. Portable and mobile RF communications equipment have no adverse effects on the Biomat.

Queen

Category		Contents
Product name		BIOMAT
Model name		Queen Biomat
Country of manufacturing		Korea
Product size		1400 x 2000 mm
Manufacturing number and manufacturing date, weight or packing unit		1) Record after manufacturing 2) Weight: 28.37 KG, packing unit: 1 set
Operating temperature		95° ~ 158°F / 35° ~ 70°C
Capability and how to use		1) Capability: Refer to the manual 2) How to use: Refer to the manual
Precaution on use		Refer to the manual
Method of keeping and storage		Refer to the manual
Other required matters	Phase, frequency, rated voltage of rated power	120V~, 60Hz, 360 W / 220-240V~, 50/60Hz, 440 W
	Protection type and level on electric shock	Class II equipment, BF-type loading part
	Other required information	Refer to the manual
Type of protection against electric shock		Class II ME equipment
Degree of protection against electric shock		Class BF applied parts - Applied parts: Top of Mat
Degree of protection against harmful ingress of water		Ordinary equipment (IPX0) - Equipment not suitable for use in presence of a flammable anesthetic mixture with air or with oxygen or nitrous oxide.
Mode of operation		Continuous operation

Class II ME equipment (single fault safe)		
	Normal Mode	Single Fault Mode
Touch Current	< 100 microA	< 500 microA
Ground Leakage Current	< 5 mA	< 10 mA

Testing in accordance with IEC 60601-1-2 indicates the following:

The Biomat needs no special precautions regarding EMC and needs to be installed and put into service. Portable and mobile RF communications equipment have no adverse effects on the Biomat.

King

Category		Contents
Product name		BIOMAT
Model name		King Biomat
Country of manufacturing		Korea
Product size		1800 x 2000 mm
Manufacturing number and manufacturing date, weight or packing unit		1) Record after manufacturing 2) Weight: 34.37 KG, packing unit: 1 set
Operating temperature		95° ~ 158°F / 35° ~ 70°C
Capability and how to use		1) Capability: Refer to the manual 2) How to use: Refer to the manual
Precaution on use		Refer to the manual
Method of keeping and storage		Refer to the manual
Other required matters	Phase, frequency, rated voltage of rated power	120V~, 60Hz, 360 W / 220-240V~, 50/60Hz, 440 W
	Protection type and level on electric shock	Class II equipment, BF-type loading part
	Other required information	Refer to the manual
Type of protection against electric shock		Class II ME equipment
Degree of protection against electric shock		Class BF applied parts - Applied parts: Top of Mat
Degree of protection against harmful ingress of water		Ordinary equipment (IPX0) - Equipment not suitable for use in presence of a flammable anesthetic mixture with air or with oxygen or nitrous oxide.
Mode of operation		Continuous operation

Class II ME equipment (single fault safe)		
	Normal Mode	Single Fault Mode
Touch Current	< 100 microA	< 500 microA
Ground Leakage Current	< 5 mA	< 10 mA

Testing in accordance with IEC 60601-1-2 indicates the following:

The Biomat needs no special precautions regarding EMC and needs to be installed and put into service. Portable and mobile RF communications equipment have no adverse effects on the Biomat.



BIOMAT

27 How to use the product

27 Turning ON and OFF

29 Adjusting the product's temperature

30 Adjusting the product's operation time

RICHWAY GROUP

How to use the product

Turning ON and OFF

Mini

The Mini Biomat is designed for the purpose of covering the abdomen and may be utilized on parts where muscle pain is experienced on the shoulder or leg.

1. Turn the Biomat on by pressing the [Power button] on the controller.
The indicator lamp will turn green.

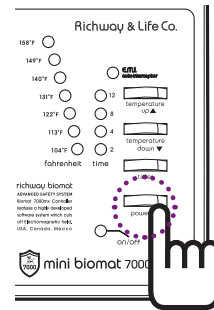

Professional / Single

The Professional / Single Biomat is designed for one-person use.

1. Press the power switch on the side of the controller to the (-) direction to turn on the power.

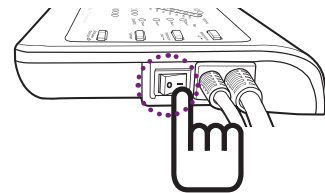

2. Turn the Biomat on by pressing the [Power] button on the controller.

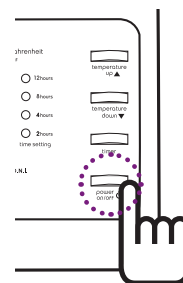

Queen / King

The Queen / King Biomat is designed for two person use. The left and right sides of the mat can be adjusted independently. The temperature and usage time can be set independently to save energy.

1. Press the power switch on the side of the controller to the (-) direction to turn on the power.

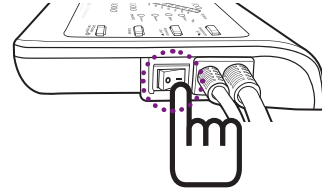

2. Turn the Biomat on by pressing the [Power] button on the controller of the side you want.

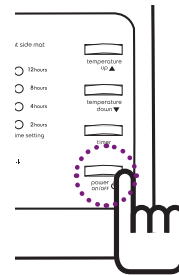

Caution

- Please check if the E.M.I./E.M.F. lamp is illuminated when the power is connected. If the lamp is not turned on after turning on the Biomat, please contact Customer Service.
- When connecting the controller / power cable, check if the E.M.I./E.M.F. auto block lamp is on. For 220V mats: If the E.M.I./E.M.F. auto block lamp does not turn on green even after power connection, unplug and re-insert the power plug in the opposite direction.
- When the 158°F / 70°C LED lamp is flashing after power connection, check if the controller and mat are properly and securely connected. To ensure a secure connection, there should be no space between the two joinings. The connection may be tight at first.
 - If the power does not turn on, unplug and re-connect the power plug again.
 - If the power does not turn on, check if the outlet voltage is the proper voltage.

If the power still does not turn on after using the methods stated above, please contact the Customer Service Center.

Recommended usage:

- Use for 40-60 minutes per day at 149°F~158°F/ 65°C~70°C.
- We recommend first time users to start at a low temperature and work your way up.
- Always drink water before and after intensive hyperthermia treatment.

Adjusting the product's temperature

- When the power is turned on, press the [Temperature Up / Down] button to set the desired temperature.

- Range of temperature:
 - Mini: 104° ~ 158°F / 40° ~ 70°C
 - Professional / Single / Queen / King: 95° ~ 158°F / 35° ~ 70°C
- When the [Temperature Up] button is pressed once, the temperature is increased 5°C (9°F) at a time, and when the [Temperature Down] button is pressed once, the temperature is decreased 5°C (9°F).

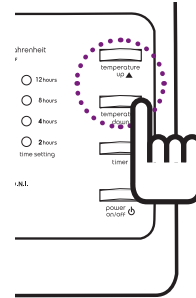

- When adjusting the temperature, the indicator lamp will change color depending on the temperature chosen.

- Set for 95° ~ 104°F (35° ~ 40°C): The blue light is illuminated on the temperature indication part of the controller.
- Set for 113° ~ 122°F (45° ~ 50°C): The green light is illuminated on the temperature indication part of the controller.
- Set for 131° ~ 140°F (55° ~ 60°C): The orange light is illuminated on the temperature indication part of the controller.
- Set for 149° ~ 158°F (65° ~ 70°C): The red light is illuminated on the temperature indication part of the controller.

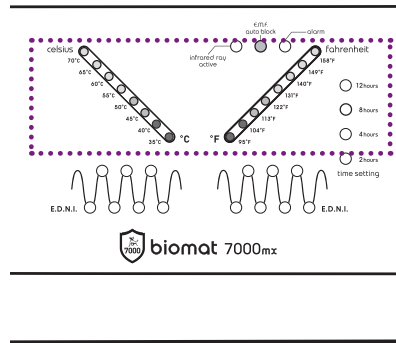

- Once selected, the Biomat will heat to the proper temperature.

- When the temperature value reaches the set temperature, the EDNI lamp will flash in blue (Professional / Single / Queen / King sizes only).

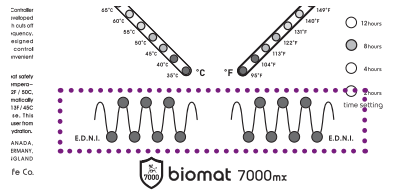

Caution

- When using the Biomat, be sure to cover it with the cotton pad. Do not lay on the Biomat directly. Doing so may cause burns or injury to your skin.
- When the waterproof cover is placed on the Biomat, it may prolong the life of the product. When using the waterproof cover, be sure to place it over the cotton pad.

Adjusting the product's operation time

- After setting the operation temperature, press the [Timer] button to adjust and set the desired operation time within the set value.

- Range of operation time: 2 / 4 / 8 / 12 hours
- Basic set value: 8 hours

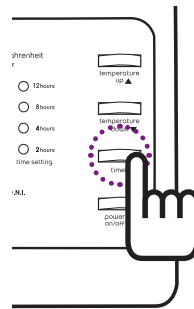

- When the operation time is set, the timer indication lamp will illuminate depending on the set value.

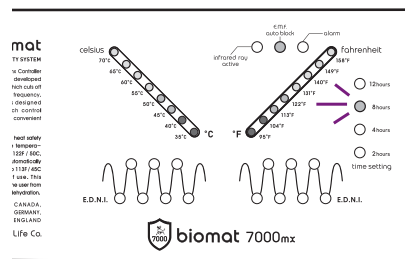

- When the set time has lapsed, it will stop the operation and the power is automatically turned off.

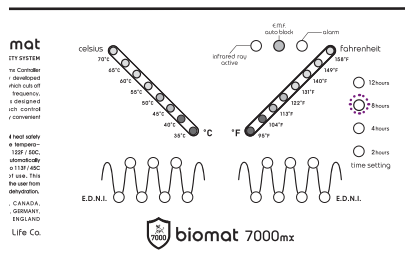

Reference

- When using the Biomat, if the timer is set for 8 or 12 hours at 131°F (55°C) or higher, it will automatically decrease the temperature to 113°F (45°C) or below after 4 hours of use for the safety of the user. When the set time is reached, the power will turn off.



BIOMAT

32 Useful information

32 How to clean and store the product

33 Trouble shooting guide

34 Check before contacting customer service

35 Customer service information

35 Product manufacturing information

41 Application specification

44 Symbol glossary

45 Product warranty

RICHWAY GROUP

Useful information

How to clean and store the product

Check after using the Biomat

- After using the Biomat, turn it off by pressing the Power button.
- When the power is turned off, separate the power plug from the outlet.

How to clean the Biomat

1. If the Biomat has any moisture or perspiration, use a dry towel to wipe it off.
 - Do not leave any moisture on the Biomat after cleaning the product.
 - We recommend wiping the vinyl strip on the Biomat once a month to maintain good condition.

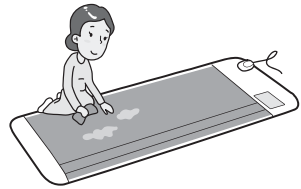

2. We recommend washing the cotton pad once a week.
 - The cotton pad can be machine washed.



Caution

- When cleaning the Biomat, do not wash with water or dry clean.
 - Doing so may cause electric shock or short circuit.
- When cleaning the Biomat, make sure to turn off the power and unplug it.

How to store the Biomat

- Store the Biomat lying flat (not folded) and in a well ventilated area.
- If you must fold the Biomat, do so the same way as you received it. Folding it in the opposite direction may cause the internal circuitry to break.
- Separate the controller from the Biomat and place it in a bag.



Caution

- In the event that the controller and stand are separated, make sure to separate by pulling in the other direction from the direction where the stand is integrated.

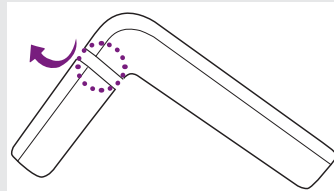

Product Storage/Transportation

The Biomat has to be stored and transported according to the following appropriate conditions.

Product Storage/ Transportation	- Storage Temperature: 32 ~ 113°F / 0 ~ 45°C - Transportation Temperature: -13 ~ 158°F / -25 ~ 70°C - Humidity: 15 ~ 93% - Air pressure: 700 ~ 1060 hPa
	- Place without humidity and out of direct sunlight - Place without dust and with good ventilation.



Caution

- Before moving the Biomat, be sure to turn it off and wait until it has cooled down.

Trouble shooting guide

If the alarm lamp on the controller flickers while using the Biomat, follow this guide. If the alarm lamp continues to flicker after following the methods below, stop use of the product and contact Customer Service.

Mini_120V

Indicator Lamp	Cause	Resolution method
158°F lamp is flickering in red	Biomat connection is not secure	• Check if the Biomat cable is appropriately connected to the controller.
	Defective temperature sensor	• Temperature sensor wire is broken. Contact our Customer Service Center.

Mini_220V

Indicator Lamp	Cause	Resolution method
“EO” is indicated in the display window	Biomat connection is not secure	• Check if the Biomat cable is appropriately connected to the controller.
	Defective temperature sensor	• Temperature sensor wire is broken. Contact our Customer Service Center.

Professional / Single / Queen / King

Indicator Lamp	Cause	Resolution method
Alarm lamp is flickering in red	Biomat connection is not secure	<ul style="list-style-type: none"> • Check if the Biomat cable is appropriately connected to the controller.
	Defective temperature sensor	<ul style="list-style-type: none"> • Temperature sensor wire is broken. Contact our Customer Service Center.

Check before contacting customer service

If there is any malfunction during the use of the product, check the following contents before contacting our Customer Service Center.

Symptom	Resolution method
The power switch is turned on but the power indicator light is not turned on.	<ul style="list-style-type: none"> • Check if the power plug is securely connected to the outlet. • Check if the voltage of the outlet is 120V or 220V. • Connect the power plug correctly, but if it still does not properly work, contact our Customer Service Center.
The temperature is set but the Biomat is not working.	<ul style="list-style-type: none"> • Check if the Biomat and the controller are correctly connected. • Turn off the power of the controller and separate the power cable and then re-connect again. • Connect the power cable correctly, but if it still does not properly work, contact our Customer Service Center.
During the use of the Biomat, the power suddenly turns off.	<ul style="list-style-type: none"> • Turn the power off and turn it on again.
The alarm lamp has the red light on and the Biomat is not working.	<ul style="list-style-type: none"> • If the alarm lamp is on, turn off the power immediately and separate the power cable and then contact our Customer Service Center.

Customer service information

If your Biomat is not working properly call our Customer Service Center.

CUSTOMER SERVICE CENTER

North America & International

Richway & Fuji Bio Inc.

Tel: 1-808-589-2800

Toll-Free: 1-855-338-6410 (USA, Canada, Guam, Saipan)

Homepage: www.richwayandfujibio.com

Email: rma@richwayusa.com

China

Shaoxing Richway Trading Co., Ltd.

Tel: +86-575-8110-1350

Europe

Richway Europe B.V.

Tel: +31-(0)20-658-6231

International: +31-(0)20-303-3411

Product manufacturing information

The certificate of complete product manufacturing is attached to the rear side of the controller and the rear side of the Biomat.

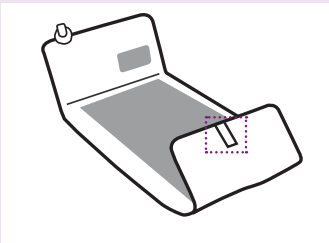

Rear side of Biomat

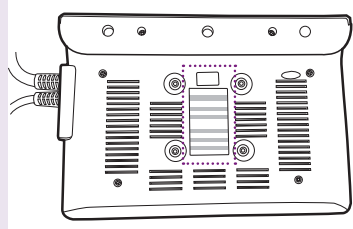

Rear side of Controller

MINI

Front



Product: Biomat Mini
 Voltage: 120 Volts
 Electric Consumption: 100 Watts
 Frequency: 60 HHz
 Manufacturer: Richway & Life Co.
 Distributed by: RICHWAY & FUJI BIO INC.
 Address: 1314 South King Street Suite 520
 Honolulu, HI 96814 U.S.A
 Tel: 808-589-2800
 Origin: **Made in Korea**

CAUTION
 TO REDUCE THE RISK OF ELECTRIC SHOCK,
 DO NOT OPEN THE MATTRESS.
 NO USER SERVICEABLE PARTS INSIDE.
 REFER SERVICING TO QUALIFIED PERSON.

READ INSTRUCTIONS CAREFULLY
 Do not use dry cleaning fluid on the mattress
 (cleaning solvent may have a deteriorating
 effect on the Insulation of the heating element).
 Do not dry clean.
 Wash by hand methods only.
 Do not machine wash or machine dry as an
 electric shock or fire may result.
 Place mattress on floor or mattress with this
 label down. Electric cord should be at head
 of bed. Let electric cord hang free.
 Do not place this mattress between mattress
 and spring box.

Side



CAUTION

TO REDUCE THE RISK OF ELECTRIC SHOCK
 DO NOT OPEN THE PANEL.
 NO USER SERVICEABLE PARTS INSIDE.
 REFER SERVICING TO QUALIFIED PERSON.
 READ INSTRUCTIONS CAREFULLY

RICHWAY & FUJI BIO INC.
www.richwayandfujibio.com
 TEL : 1-800-589-2800
 1314 South King Street Suite 520
 Honolulu, HI 96814 U.S.A

PRODUCT : BIOMAT MIN
 VOLTAGE : 120Volts
 ELECTRIC CONSUMPTION : 100W
 FREQUENCY : 60Hz
 MANUFACTURER : R & L CORPORATION,
 DISTRIBUTED BY RICHWAY & FUJI BIO INC.

MADE IN KOREA

MODEL NUMBER : BIOMAT MINI
 FDA 510K : K072534
 TRADEMARK : BIOMAT

PROFESSIONAL

Front



Product: Biomax Professional
 Voltage: 120 Volts
 Electric Consumption: 150 Watts
 Frequency: 60 Hz
 Manufacturer: Richway & Life Co.
 Distributed by: RICHWAY & FUJI BIO INC.
 Address: 1214 South King Street Suite 520
 Honolulu, HI 96814 U.S.A
 Tel: 808-589-2800
 Origin: **Made in Korea**

CAUTION
 TO REDUCE THE RISK OF ELECTRIC SHOCK,
 DO NOT OPEN THE MATRESS.
 NO USER SERVICEABLE PARTS INSIDE.
 REFER SERVICING TO QUALIFIED PERSON.
READ INSTRUCTIONS CAREFULLY
 Do not use dry cleaning fluid on the matress
 cleaning Solvent may have a deteriorating
 effect on the insulation of the heating element.
 Do not dry clean.
 Wash by hand methods only
 Do not machine wash or machine dry as an
 electric shock or fire may result.
 Place matress on floor or matress with this
 label down. Electric cord should be at head
 of bed. Let electric cord hang free.
 Do not place this matress between matress
 and spring box.

Side



CAUTION

TO REDUCE THE RISK OF ELECTRIC SHOCK,
 DO NOT OPEN THE PANEL.
 NO USER SERVICEABLE PARTS INSIDE,
 REFER SERVICING TO QUALIFIED PERSON.

READ INSTRUCTIONS CAREFULLY

Product : Biomax Professional
 Voltage : 120Volts
 Electric Consumption : 150W
 Frequency : 60Hz
 Manufacturer : R & L Corporation
 Distributed by : RICHWAY & FUJI BIO INC.
 Address : 1214 South King Street Suite 520
 Honolulu, HI 96814 U.S.A
 Tel : 808-589-2800
 Origin : Made in Korea

RICHWAY & FUJI BIO INC.

www.richwayandfujibio.com

Tel : 1-808-589-2800

Model Number : BIOMAT PROFESSIONAL

FDA 510K: K072534

Trade mark : Bio Mat

SINGLE

Front



Product: Biomatt Single
Voltage: 120 Volts
Electric Consumption: 180 Watts
Frequency: 60 HHz
Manufacturer: Richway & Life Co.
Distributed by: RICHWAY & FUJI BIO INC.
Address: 1314 South King St 520
Honolulu HI 96814 USA
Tel: 808 589 2900
Origin: **Made in Korea**

CAUTION
TO REDUCE THE RISK OF ELECTRIC SHOCK,
DO NOT OPEN THE MATTRESS.
NO USER SERVICEABLE PARTS INSIDE.
REFER SERVICING TO QUALIFIED PERSON.

READ INSTRUCTIONS CAREFULLY
Do not use dry cleaning fluid on the mattress
cleaning solvent may have a deteriorating
effect on the insulation of the heating element.
Do not dry clean
Wash by hand methods only
Do not machine wash or machine dry as an
electric shock or fire may result
Place mattress on floor or mattress with this
label down. Electric cord should be at head
of bed. Let electric cord hang free.
Do not place this mattress between mattress
and spring box.

Side



CAUTION

TO REDUCE THE RISK OF ELECTRIC SHOCK,
DO NOT OPEN THE PANEL,
NO USER SERVICEABLE PARTS INSIDE,
REFER SERVICING TO QUALIFIED PERSON.

READ INSTRUCTIONS CAREFULLY

Product : Biomatt Single
Voltage : 120Volts
Electric Consumption : 180Watts
Frequency : 60Hz
Manufacturer : R & L Corporation
Distributed by : RICHWAY & FUJI BIO INC.
Address : 1314 South King Street Suite 520
Honolulu, HI 96814 U.S.A
Tel : 808 589 2900
Origin : Made in Korea

RICHWAY & FUJI BIO INC.

www.richwayandfujibio.com

Tel : 1-808-589-2900

Model Number : BIOMATT SINGLE

FDA 510K : K072534

Trade mark : Bio Mat

QUEEN

Front



Product: Biomax Queen
Voltage: 120 Volts
Electric Consumption: 360 Watts
Frequency: 60 Hz
Manufacturer: Richway & Life Co.
Distributed by: RICHWAY & FUJI BIO INC.
Address: 1314 South King St. 520
Honolulu HI 96814 USA
Tel: 808 589 2800
Origin: **Made in Korea**

CAUTION
TO REDUCE THE RISK OF ELECTRIC SHOCK,
DO NOT OPEN THE MATTRESS.
NO USER SERVICEABLE PARTS INSIDE.
REFER SERVICING TO QUALIFIED PERSON.
READ INSTRUCTIONS CAREFULLY
Do not use dry cleaning fluid on the mattress
cleaning solvent may have a deteriorating
effect on the insulation of the heating element.
Do not dry clean.
Wash by hand methods only
Do not machine wash or machine dry as an
electric shock or fire may result.
Place mattress on floor or mattress with this
label down. Electric cord should be at head
of bed. Let electric cord hang free.
Do not place this mattress between mattress
and spring box.

Side



CAUTION
TO REDUCE THE RISK OF ELECTRIC SHOCK,
DO NOT OPEN THE PANEL,
NO USER SERVICEABLE PARTS INSIDE,
REFER SERVICING TO QUALIFIED PERSON.

READ INSTRUCTIONS CAREFULLY

Product : Biomax Queen
Voltage : 120Volts
Electric Consumption : 360Watts
Frequency : 60Hz
Manufacturer : R & L Corporation
Distributed by : RICHWAY & FUJI BIO INC.
Address : 1314 South King Street Suite 520
Honolulu, HI 96814 U.S.A
Tel : 808 589 2800
Origin : **Made in Korea**

RICHWAY & FUJI BIO INC.
www.richwayandfujibio.com
Tel : 1-808-589-2800
Model Number : BIOMAT Queen
FDA 510K: K072534
Trade mark : Bio Mat

KING

Front



Product: Biommat King
Voltage: 120 Volts
Electric Consumer: 360 Watts
Frequency: 60 HHz
Manufacturer: Richway & Life Co.
Distributed by: RICHWAY & FUJI BIO INC.
Address: 1314 South King St. 520
Honolulu HI 96814 USA
Tel: 808 589 2800
Origin: **Made in Korea**

CAUTION
TO REDUCE THE RISK OF ELECTRIC SHOCK,
DO NOT OPEN THE MATTRESS.
NO USER SERVICEABLE PARTS INSIDE.
REFER SERVICING TO QUALIFIED PERSON.

READ INSTRUCTIONS CAREFULLY
Do not use dry cleaning fluid on the mattress
cleaning solvent may have a deteriorating
effect on the insulation of the heating element.
Do not dry clean.
Wash by hand methods only.
Do not machine wash or machine dry as an
electric shock or fire may result.
Place mattress on floor or mattress with this
label down. Electric cord should be at head
of bed. Let electric cord hang free.
Do not place this mattress between mattress
and spring box.

Side



CAUTION

TO REDUCE THE RISK OF ELECTRIC SHOCK,
DO NOT OPEN THE PANEL.
NO USER SERVICEABLE PARTS INSIDE.
REFER SERVICING TO QUALIFIED PERSON.

READ INSTRUCTIONS CAREFULLY

Product: Biommat King
Voltage: 120Volts
Electric Consumer: 360Watts
Frequency: 60Hz
Manufacturer: R & L Corporation
Distributed by: RICHWAY & FUJI BIO INC.
Address: 1314 South King Street Suite 520
Honolulu, HI 96814 U.S.A
Tel: 808 589 2800
Origin: Made in Korea

RICHWAY & FUJI BIO INC.

www.richwayandfujibio.com

Tel: 1-800-589-2800

Model Number: BIOMMAT King

FDA 510K: K072534

Trade mark: Bio Mat

Application specification

INDICATION FOR USE

The Biomat is indicated for the temporary relief of minor muscle and joint pain and stiffness; the temporary relief of joint pain associated with arthritis; the temporary relief of muscle spasms, minor sprains and strains, and minor muscular back pain; the relaxation of muscles; and the temporary increase of local circulation where applied.

ESD Information

ESD	6kV Contact Discharge; 8kV air discharge
Power frequency magnetic fields	3 A/m at 60 Hz
Conducted RF	150 kHz - 80MHz (3Vrms)
Radiated RF	80 MHz - 2500 MHz (3V/m)

The Biomat is intended for use in the electromagnetic environment specified below. The customer or the user of the Biomat should assure that it is used in such an environment.			
Immunity Test	IEC 60601 Test Level	Compliance Level	Electromagnetic Environment - Guidance
Conducted RF IEC 61000-4-6	3Vrms 150kHz-80MHz	3Vrms	Portable and mobile RF communications equipment should be used no closer to any part of the Biomat, including cables, than the recommended separation distance calculated from the equation applicable to the frequency of the transmitter. Recommended separation distance $d = 1.2\sqrt{P}$ $d = 1.2\sqrt{P} \text{ 80MHz to 800MHz}$ $d = 2.3\sqrt{P} \text{ 800MHz to 2.5GHz}$
Radiated RF IEC 61000-4-3	3V/m 80MHz-2500 MHz	3V/m	Where P is the maximum output power rating of the transmitter in watts(W) according to the transmitter manufacturer and d is the recommended separation distance in meter(m).Field strengths from fixed RF transmitter, as determined by and electromagnetic site survey should be less than the compliance level in each frequency range.Interference may occur in the vicinity of equipment marked with the following symbol; 
NOTE 1 At 80 MHz and 800 MHz, the higher frequency range applies. NOTE 2 These guidelines may not apply in all situations. Electromagnetic propagation is affected by absorption and reflections from structures, object and people.			

- a. Field strengths from fixed transmitters, such as base stations for radio (cellular/cordless) telephones and land mobile radios, amateur radio, AM and FM radio broadcast and TV broadcast cannot be predicted theoretically with accuracy. To assess the electromagnetic environment due to fixed RF transmitters, an electromagnetic site survey should be considered. If the measured field strength in the location in which the Biomat is used exceeds the applicable RF compliance level above, the Biomat should be observed to verify normal operation. If abnormal performance is observed, additional measures may be necessary, such as reorienting or relocating the Biomat.
- b. Over the frequency range 150 kHz to 80 MHz, field strengths should be less than [V1] 3 V/m.

Recommended separation distance
between portable and mobile RF communications equipment and the Biomat

The Biomat is intended for use in an electromagnetic environment in which radiated RF disturbances are controlled. The customer or the user of the Biomat can help prevent electromagnetic interference by maintaining a minimum distance between portable and mobile RF communications equipment(transmitter) and Biomat as recommended below, according to the maximum output of the communications equipment.











Rated maximum output power of transmitter W	Separation distance according to frequency of transmitter m		
	150 kHz to 80 MHz $d = 1.2\sqrt{P}$	80 MHz to 800 MHz $d = 1.2\sqrt{P}$	800 MHz to 2.5GHz $d = 2.3\sqrt{P}$
0.01	0.12	0.12	0.23
0.1	0.38	0.38	0.73
1	1.2	1.2	2.3
10	3.8	3.8	7.3
100	12	12	23

For transmitters rated at a maximum output power not listed below, the recommended separation distance d in meter(m) can be estimated using the equipment applicable to the frequency of the transmitter, where P is the maximum output power rating of the transmitter on watts(W) according to the transmitter manufacturer.

NOTE 1 At 80 MHz and 800 MHz, the separation distance for the higher frequency range applies.

NOTE 2 These guidelines may not apply in all situations. Electromagnetic propagation is affected by absorption and reflection from structures, objects, and people.

Symbol glossary

Symbol	Meaning
	Symbols of general warning
	General warning sign
	Type BF Applied part
	CLASS II equipmet
~	Alternating Current
	Waste disposal
	Stepping prohibited
	Sitting prohibited
	Keep dry
	Serial Number
	“ON” (power) To indicate connection to the main power source, at least for mains switches or their positions, and all those cases where safety is involved.
○	“OFF”(power) To indicate disconnection from the main power source, at least for mains switches or their positions, and all those cases where safety is involved.
	Stand-by To indicate the switch or switch position by means of which part of the equip-ment is switched on in order to bring it into the stand-by condition.
	Refer to instruction manual

Product warranty

Order information	Product name	Biomat	Model name	
	Warranty period	Limited 3 years from the date of product purchase	Manufacturing number	
	Date of purchase		Branch of purchase	
Customer information	Name		Purchase price	

Richway & Fuji Bio warrants the covered product to be free from defects and malfunctions at the time sold. "Defects" as used in this warranty, is defined as imperfections, which impair or impede the function and use of the product.

How Long the Warranty Lasts

This warranty lasts 3 years from the date of delivery. This warranty extends to the original purchaser only. Coverage terminates if you sell or otherwise transfer ownership.

What This Warranty Covers

This warranty covers any defects or malfunctions in the electronic components, heating element, and top cover replacement. If Richway & Fuji Bio determines that such goods are defective, within the period of this warranty, Richway & Fuji Bio will repair or replace the parts free of charge for the first year. Repair or replacement for the second and third year requires a fee, which can be found on our website. Repair or replacement is the sole and exclusive remedy available to the buyer, and shall constitute the fulfillment of all Richway & Fuji Bio obligations in respect to the goods furnished under this agreement.

What This Warranty Does Not Cover

This warranty does not cover abuse, misuse, natural disaster, insufficient or excessive electrical supply, ordinary wear, fading, failure to follow instructions and improper maintenance. Richway & Fuji Bio shall not be liable for any incidental or consequential damages as a direct result of negligence or misuse. This warranty does not extend to the purchase of opened, used, repaired, repackaged, and/or resealed products, including but not limited to sale of such products on internet sites and/or sales of such products on internet auction sites and/or sales of such products by surplus or bulk resalers. Any and all warranties or guarantees shall immediately cease and terminate as to any products or parts thereof which are repaired, replaced, altered, or modified, without the prior express and written consent of Richway & Fuji Bio.

How to Get Service

To obtain service under this warranty, contact your local Customer Service Center and provide the purchaser's name, RI (Richway Invoice) number, and a detailed description of the problem you are experiencing. They will provide you with a return merchandise authorization number (RMA). This number is required and must be placed in a visible area on the front of the package. Ship your product postage paid, include a copy of the original sales slip, credit card receipt or other proof of the date of the original retail purchase. If servicing within the first two (2) months, we will send you a prepaid shipping label to cover your shipping costs. If servicing from the third month and on, the customer is responsible for shipping costs to return the product for repair or replacement. We will cover the shipping costs to return the product back to the customer.

How Do State Laws Apply

This warranty gives you specific legal rights, and you may also have other rights which vary from state to state. Any implied warranties last the duration of this warranty. Some states do not allow limitations on how long an implied warranty lasts and some states do not allow the exclusion or limitation of incidental or consequential damages, so the limitations or exclusions may not apply to you.

**THE
RICHWAY
GROUP**

RICHWAY & FUJI BIO INC.

1314 South King Street Suite 520, Honolulu, HI 96814 USA

Tel: 1-808-589-2800/ Toll-Free: 1-855-338-6410

Homepage: www.richwayandfujibio.com



Manufacturer: R&L Co., Ltd.

Address: 11F, Ace Gwangmyeong Tower B, 108 Haan-Ro,
Gwangmyeong-Si, Gyeonggi-Do, Korea 14319